



LSTG SERIES SOLAR INVERTER



For more services please call **09-788 788 678**

User Manual

Content

1. Installation Instructions	1
2. Outlook of Inverter	3
3. LCD display	4
4. Operation	7
5. Wiring	12
6. Maintenance	14
7. Error and Solution	14
8. Technical specification	15
9. Appendix--485 Communication Port	16
10. Appendix(Maintenance Record&Certificate)	17



Warning

This is A class inverter. It might cause slightly radio interference in daily life. And practical measure is required to take under this condition.

Preface

Thank you for the purchase solar inverter (Hereinafter referred to as inverter). Please read this manual carefully before installing and using the inverter!

Copyright

We have been devoted to technological innovation and aims to meet the demands of its customers with better product and services. And product design and specification would be updated without prior notice. Please in kind prevail!

1.Installation Instructions

1-1: Open-package inspection

1. After opening the package, please check random accessories, including user manual (contains conformity certificate and warranty card), 2pcs battery cables and accessories for optional functions. And check whether the inverter is still kept well after transportation, if find any broken or component missing, do not turn on the machine, feedback to the carrier and distributor.

Note:

- > Please keep the packing box and packing material, can be used for next delivery if needed.
- > This series of product is very heavy (check appendix as reference), please handle with care when carrying.

1-2: Installation notice

- 1) Install in an area of well ventilated, free of water, burning gas and corrodent.
- 2) Not good to put on the side, better keep good air ventilation from front panel's bottom air intake, or air outlet from back panel's fan, and side face of machine.
- 3) Around environment temperature should remain 0 to 40 centigrade.
- 4) If disassembling and operate under low temperature environment, may happen water condense, only can work till thorough dry of machine inside and outside, otherwise will be shock risk.
- 5) If the machine is placed for a long time, it should be confirmed that the machine is completely dry and no corrosion can be installed and used.

1-3:Installation steps

- 1) Environmental requirements

Open the package and place the inverter in a reasonable working environment. Refer to the "Installation Precautions" for specific requirements.

- 2) Wire diameter selection

Use a cable with a suitable wire diameter, which can not be lower than the national safety standard. The general wire diameter is selected according to the current density of not more than 5A/mm², and the length of the connecting wire is minimized to reduce the loss.

- 3) Connect the battery

Determine the appropriate number of battery cells according to the rated battery voltage of the inverter. Connect the battery cable to a circuit breaker that meets the breaking capacity, and then connect it to the BATTERY terminal of the inverter. Note that the positive and negative poles cannot be reversed. Otherwise, the product may be damaged.

- 4) Connect the load

Turn off all loads firstly, then connect the DC load to the DC output of the inverter (DC OUTPUT) , and connect the AC load to the AC output of the inverter (AC OUTPUT), confirming that the load polarity is not reversed, and ensure the load is lower than the standard power of the inverter.

- 5) Connect the PV

Connect the PV cable to the circuit breaker that meets the breaking capacity, and then connect it to the PV input terminal of the inverter. the PV array open circuit voltage and short circuit current should be lower than the maximum PV input voltage and current of the rated charge controller. Note:Be careful not to reverse the polarity.

- 6) Connect the mains

Connect the mains input cable to a circuit breaker that meets the breaking capacity, and then connect it to the AC input terminal of the inverter. Note that the phase and polarity are not reversed.

- 7) Selection of circuit breaker

- a. The circuit breaker on the battery side should be a DC circuit breaker whose working voltage should be greater than the rated voltage of the battery; the circuit breaker on the PV input side should be a DC circuit breaker whose working voltage should be greater than the rated voltage of the PV array; the circuit breaker on the AC input side should be an AC circuit breaker whose working voltage should be greater than the rated voltage of the mains.
- b. The rated current of the circuit breaker should be about 1.5 times of the maximum current inverter during operation





Note:

- Before connecting the load to the machine, please turn off the loads firstly.
- This product can only protect high-voltage surges with low energy. In areas with high lightning output, it is recommended to install lightning protection devices outside the PV input terminals.
- To ensure the personal safety of the user and ensure the correct use of the product, please confirm that it is properly grounded before starting the machine.
- If user want to load an inductive load such as a motor or a laser printer which operating power is too large, the inverter rated capacity should be selected according to its peak power .The load starting power is generally 2 to 3 times of its rated power.

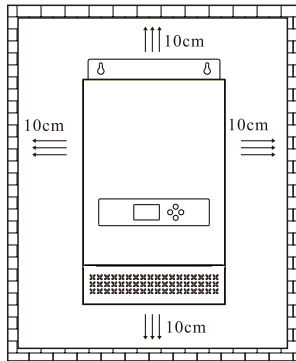
1-4: Placement

Please leave 10cm of space for each side of inverter to keep good air circulation.
 (Only suitable for installation on concrete or other non-combustible surfaces)



-  ★ Avoid direct sunlight
-  ★ Avoid dust
-  ★ Avoid moisture and liquids
-  ★ Avoid over heating

1-5: Installation size

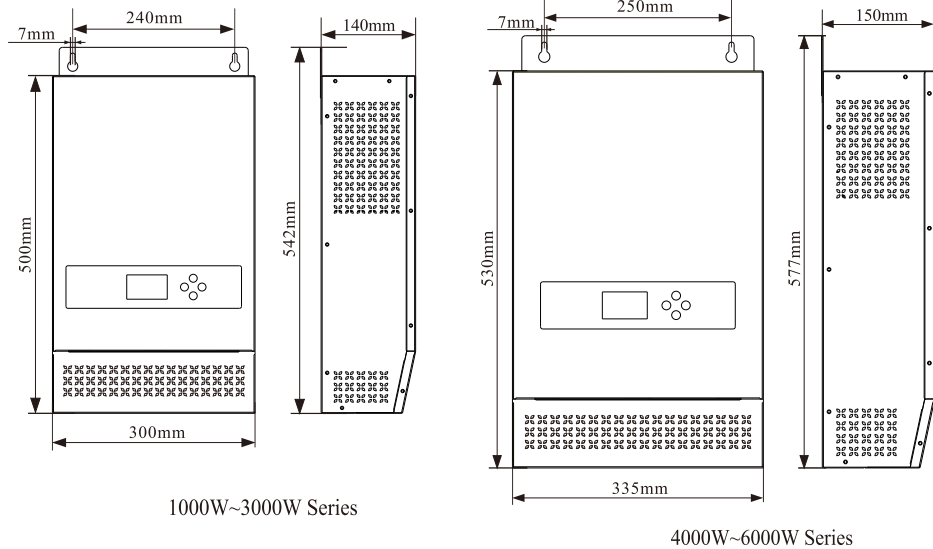

2. Outlook of Inverter

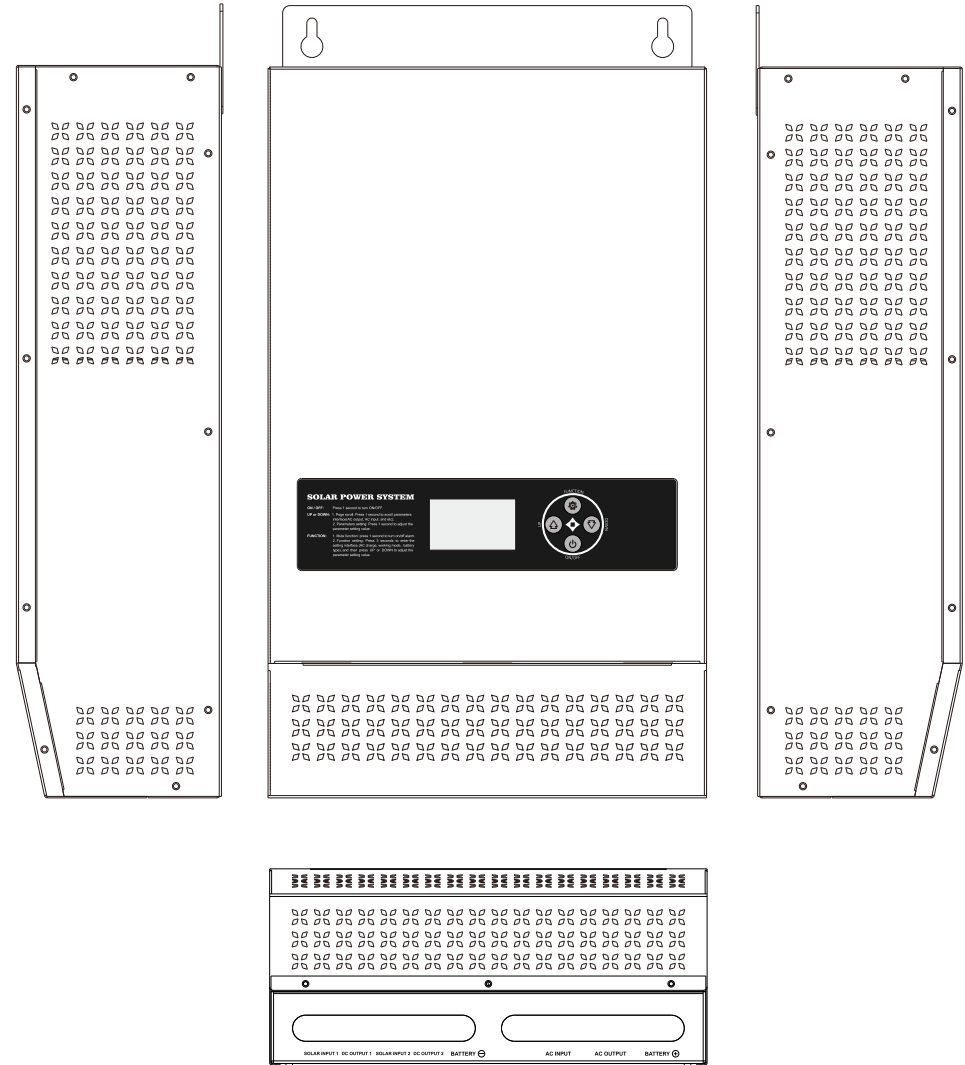

Note: Images may be slightly different from actual product. Please in kind prevail!

3. LCD screen description

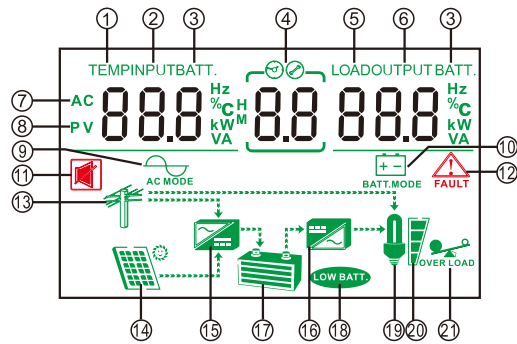

Parameter display area

1 TEMP: Temperature displayed
2 INPUT: Mains input data displayed
3 BATT: Battery data displayed
4 When emergency come, shows alarm code here.
5 LOAD: Load data displayed
6 OUTPUT: AC output data displayed
7 AC: AC data displayed
8 PV: PV input data displayed

Icon display area

9 AC MODE: AC mode (means the inverter is already on d1 or d2 (Based on the real setting value))		
10 BATT.MODE: BATT.MODE means the inverter is already on d3: battery mode		
11: Turn mute on/off	12: FAULT: fault alarm	
13: Utility	14: Solar panel (Display when there is a built-in PV controller)	
15: AC charging and PV charging icons	16: Battery powered icons	17: Battery
18: Low battery alarm	19: Load	
20: Load capacity (The load is divided into 4 grids, and the single-grid load is 25% of the full load)		
21: Overload alarm		

3-1. Work flow chart icon introduction (Built-in solar controller)

1) Mains working mode (No PV input, Only the mains charge the battery)

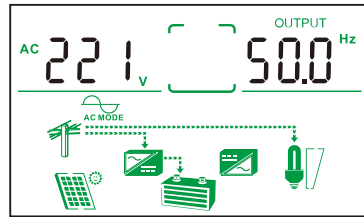

2) Mains working mode (Has PV input, the mains and the PV simultaneously charge the battery)

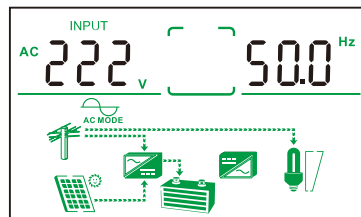

3) Battery working mode (No mains and PV input)

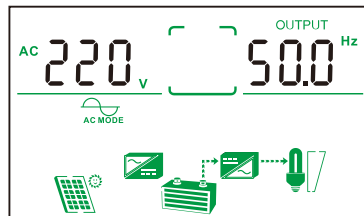

4) Battery working mode (Has PV input but no mains input, only the PV charge the battery)

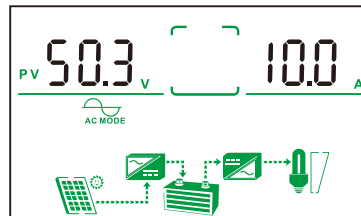

3-2. Introduction to the work interface (Built-in solar controller) (Mains and PV input are normal)

1) Output interface (Display output voltage and frequency)

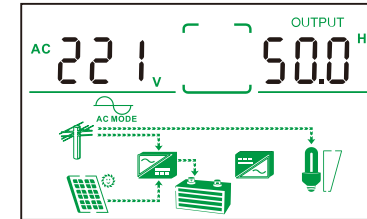

2) AC input interface (Display AC input voltage and frequency)

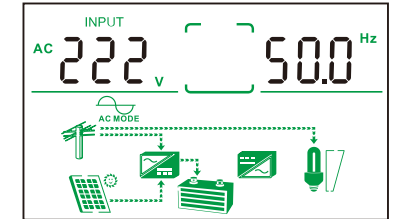

3) PV interface (Display PV voltage and PV current)

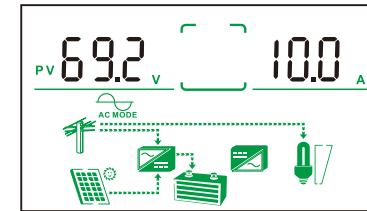

4) Battery interface (Display battery voltage and percentage)

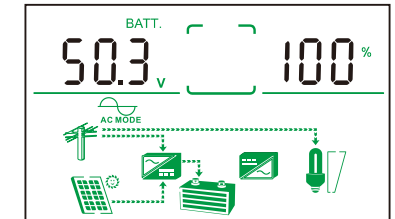

5) Loads interface (Display load power and load percentage)

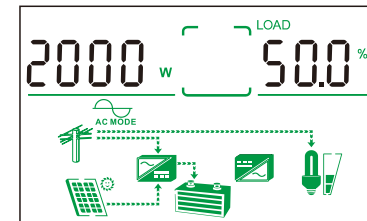

6) PV generation capacity / Actual power generation interface

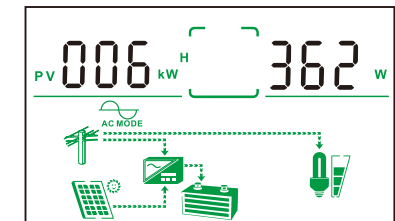

7) Controller Max charging current interface

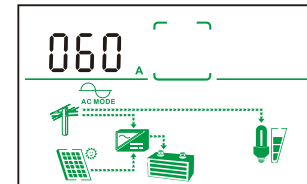

8) Internal temperature interface

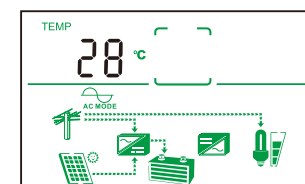

9) Communication address interface

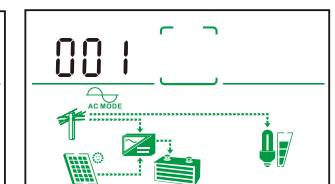

3-3. Three working modes(Built-in solar controller)

1) d1: Mains priority mode (Display AC MODE icon, the working mode depends on the setting value)

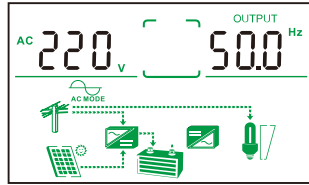

2) d2: Energy saving mode (Display AC MODE, the working mode depends on the setting value)

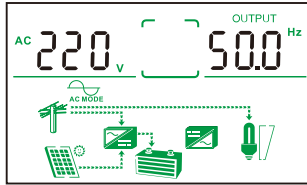

3) d3: Battery priority mode (Display BATT.MODE icon)

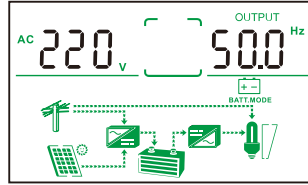

Note: The actual display parameters are subject to the specific model, and the picture display contents are only used as examples.

Remarks: Introduction to three working modes

1) Mains priority mode(d1)

- When the mains is normal (in line with the mains input voltage range of the inverter), the mains charge battery (if with built-in solar controller, the mains and PV charge the battery simultaneously); on the other hand, the mains supplies stable power to the loads after stabilization. (the loads do not consume PV and battery energy);
- When the mains is abnormal (the mains exceeds the working range of the inverter or the mains supply is interrupted), the loads will be powered by the battery (if with built-in controller, when PV power rate is larger than the loads, PV will power the loads and the surplus energy will charge the battery; when PV power rate is less than the loads, the deficiency will be made up by battery, so both PV and battery will power the loads).

2) Battery(Solar) priority mode(d3)

- When the battery is fully charged (like single-cell battery voltage is up to 13.2VDC), even the mains is normal, the loads will be powered by the battery (if with built-in controller, when PV power rate is larger than that of the loads, PV will fully power the loads and the surplus energy will charge the battery; when PV power rate is less than the loads, the deficiency will be made up by battery, so both PV and battery will power the loads);
- When the battery is in low voltage (the voltage of regular single-cell battery is 11VDC) and the mains is normal, the inverter will switch to mains priority mode. The mains supplies power to the load after stabilization, and the mains charges battery simultaneously (if with built-in controller, PV and the mains charge the battery simultaneously. The loads do not consume the energy of PV and battery).

Remarks: Under Mains Priority Mode/ Battery Priority Mode, when the mains charging current is not set as 0A, the mains charge battery; when the mains charging current is set to 0A, the mains does not charge battery, but the solar controller charges the battery.

3) Energy saving mode(d2)

- Inverter works under the battery mode, once the load capacity is less than 5% of the inverter rated power, the inverter will start and stop regularly to achieve energy saving effect (ie: the machine will intermittently interrupt the inverter output); When the load is greater than 5% of the inverter rated power, the inverter will out of this energy saving mode.

4. Operation

4-1: Function and setting of button on board



1) ON/OFF button

- ◆ Battery supply state: Power on, press ON/OFF button for 1 second, the equipment start output; Power off, press ON/OFF button for 1 second, the equipment shutdown.
- ◆ AC supply state: Power on, the equipment will auto start when AC supply input; Power off, press ON/OFF button for 1 second, the equipment turn off output, the equipment shutdown after cut off AC supply.

2) UP/DOWN button

- ◆ Page scroll: in the main interface, short press the UP or DOWN button for 1 second to view various parameter interfaces, such as output interface, input interface, battery interface, and etc.;
- ◆ Parameters setting: in the parameters setting interface, short press the UP or DOWN button for 1 second to adjust the parameter value.

3): FUNCTION button

- ◆ Mute function: In the main interface, press the FUNCTION button for 1 second to turn on/off alarm.
- ◆ In the main interface, long press the FUNCTION button for 3 seconds to enter the parameters setting interface.

4-2: Function setting description

4-2-1 Introduction to function setting interface

Interface	Descriptions	Remarks
A0 Working Mode	Can be set: d1 AC input priority, d2 ECO mode, d3 solar(battery) priority	
A1 AC charging current	Settable range: C0~C6 (C0=0A, C6 is max charging)	
A2 Constant charge voltage	Settable range: 13V~15V(single battery)	Constant charge voltage
A3 Floating charge voltage	Settable range: 13V~15V(single battery)	Floating charge voltage
A4 Low voltage protection	Settable range: 8V~13V(single battery)	
A5 Auto start output recover voltage(optional)	Settable range: 9V~15V(single battery)	Inverter turn off output when battery low voltage, inverter auto turn on output when battery voltage reach to recover voltage (optional)
A6 Mains supply to inverter supply voltage (available in d3 mode)	Settable range: 9V~15V(single battery)	In d3 working mode, battery voltage from mains supply to inverter supply (Please see Chapter 3 for the working mode of d3 priority mode).
A7 Inverter supply to Mains supply voltage (available in d3 mode)	Settable range: 8V~14V(single battery)	In d3 working mode, battery voltage from inverter supply to mains supply (Please see Chapter 3 for the working mode of d3 priority mode).
A8: AC output frequency	50Hz/60Hz available to set	
A9: AC output voltage	220VAC/230VAC/240VAC available to set	

Note:

1. when setting voltage parameters, the following conditions shall be met, otherwise the inverter will report A19 fault.

1). Voltage $A2 \geq A3 > A6$ (valid in D3 mode) $\geq A5$ (optional) $> A4$;

2). Voltage $A6 > A7 > A4$;

3). If the inverter keeps alarming A19 and cannot be used normally, the machine can be restarted manually as well not save the setting data and restore the factory default value (if the parameter setting is correct, i.e. no A19 fault report, the inverter will automatically save the data).

2. Other battery voltage parameter values (default)

1) Battery high voltage alarming voltage value can't be set, and the default value is 0.8V higher than the present constant charge voltage value.

2) Low voltage alarming voltage value can't be set, and the default value is 0.5V higher than the present low voltage protection.

4-2-2 Operation guide for main interface to enter parameter setting interface

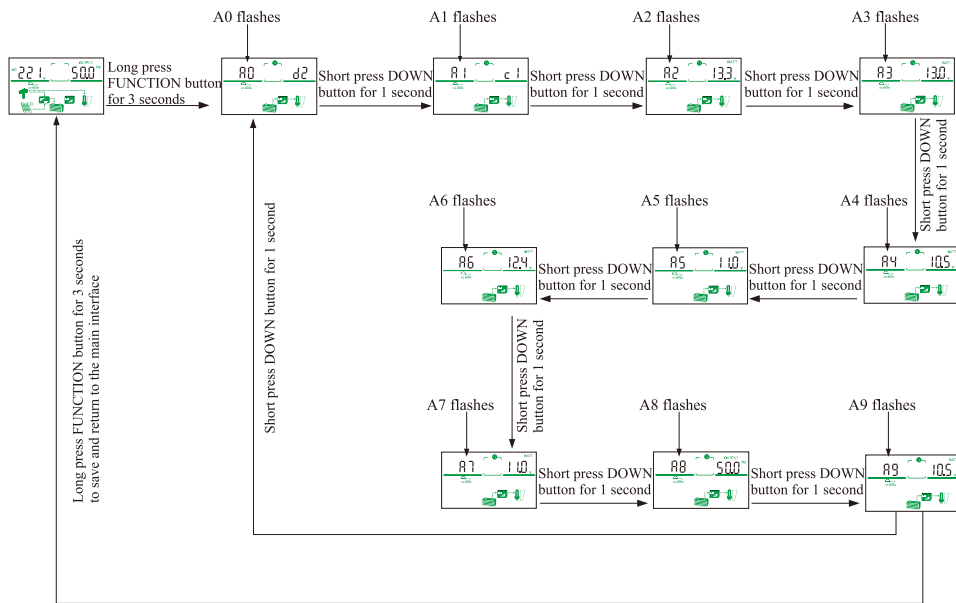

Note: the parameter of each parameter setting interface can be viewed at this time.

3) Operation guide for parameter setting in setting interface

① A0: Working priority mode setting

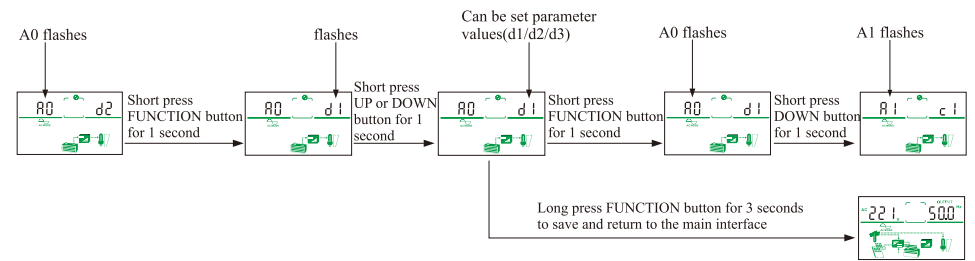

② A1: AC charging current setting

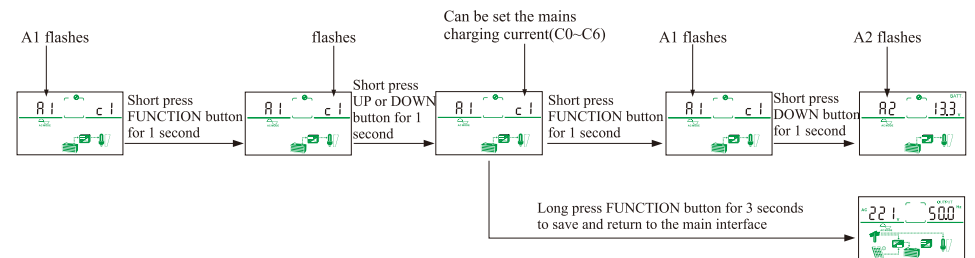

③ A2: Constant charge voltage setting

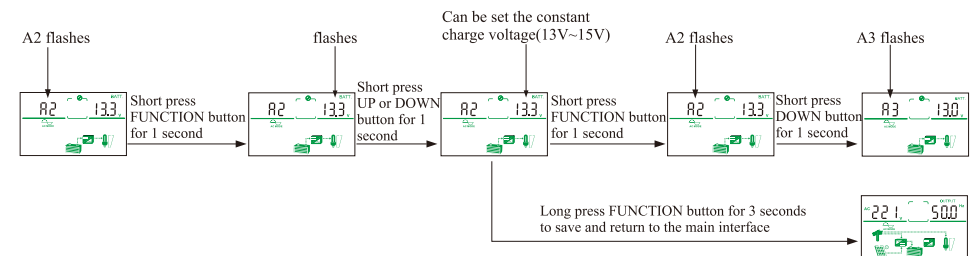

④ A3: Floating charge voltage setting

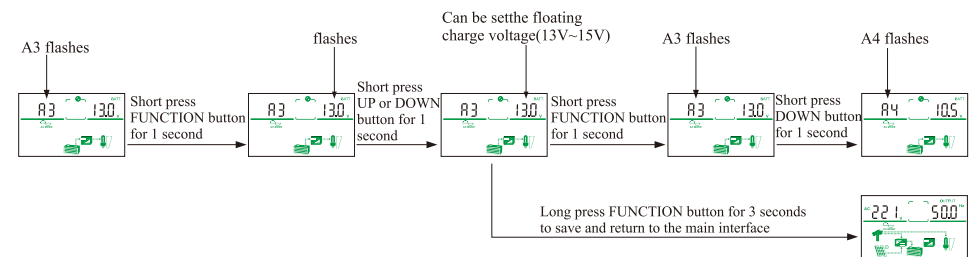

⑤ A4: Low voltage protection setting

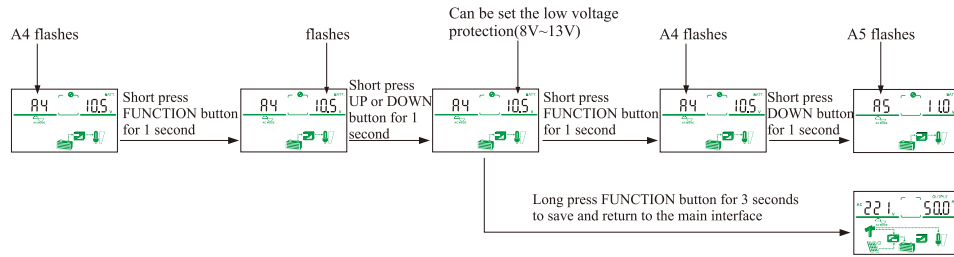

⑥ A5: Auto start output recover voltage setting(optional)

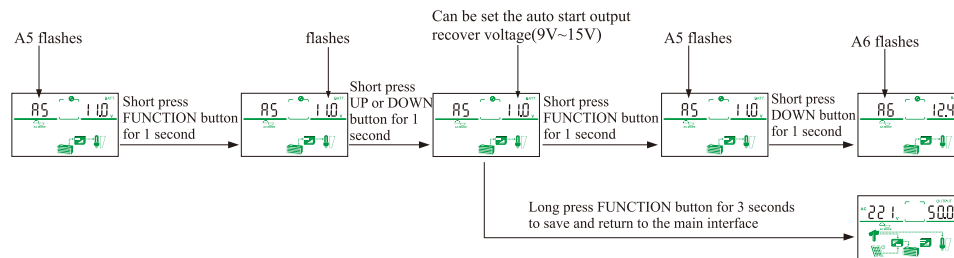

⑦ A6: Mains supply to inverter supply voltage setting (available in d3 mode)

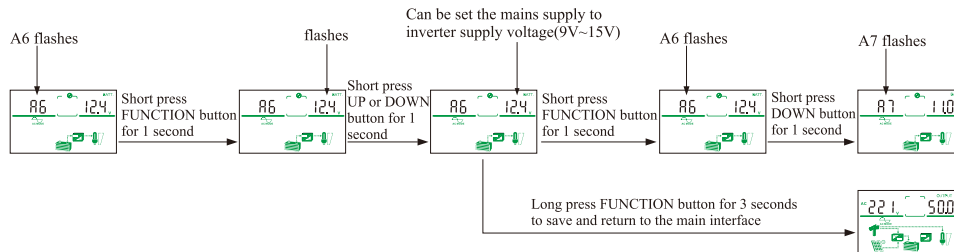

⑧ A7: Inverter supply to Mains supply voltage setting (available in d3 mode)

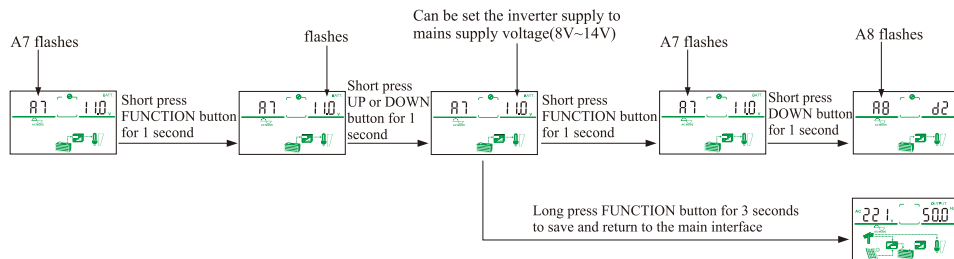

⑨ A8: AC output frequency setting

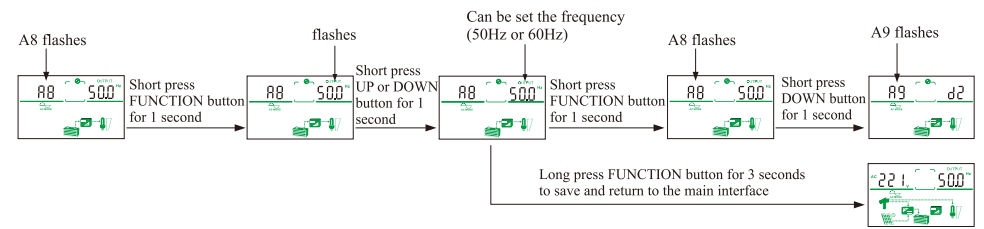

⑩ A9: AC output voltage setting

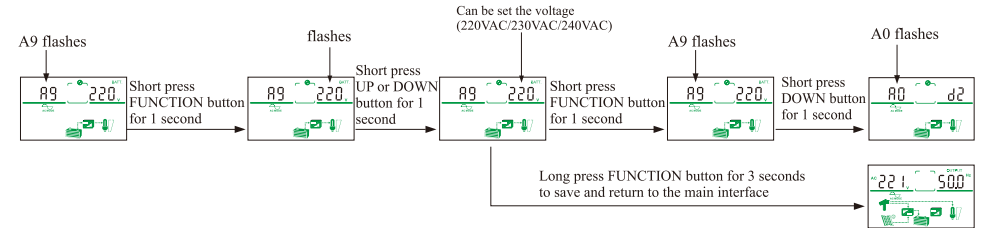

Note: If no operation is performed under the function setting page, data will be saved automatically after 40S and return to the main interface.

4-3: Steps of start up

- 1) Connect loads to the AC output of inverter.
- 2) Connect mains power, PV and batteries, please notice the negative and positive side during wiring(refer to chapter 5 for wiring).
- 3) Press ON/OFF button to start the inverter(start automatically under the state of mains power).
- 4) After 30s when the output is stable, start loads in turn.

4-4: Steps of power off

- 1) Disconnect loads.
- 2) Press ON/OFF button to disconnect AC output.
- 3) Disconnect mains power and inverter shut down.

5. Wiring

(Remarks: Please refer to the technical parameter table for specific battery voltage and solar panel parameter, This diagram is only for wiring diagram. 12V system: single 12V battery; 24V system: 2 units 12V battery connect in series; 48V system: 4 units 12V battery connect in series.)

5-1: 12V series battery wiring diagram

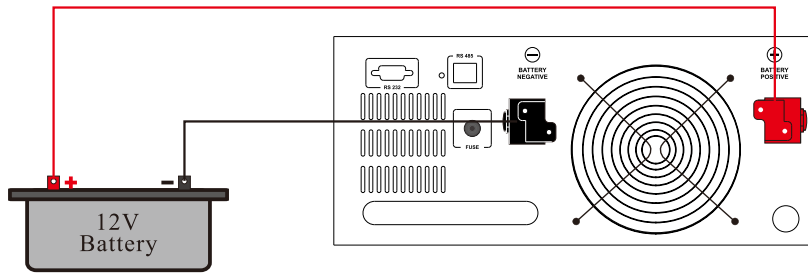

5-2: 24V series battery wiring diagram

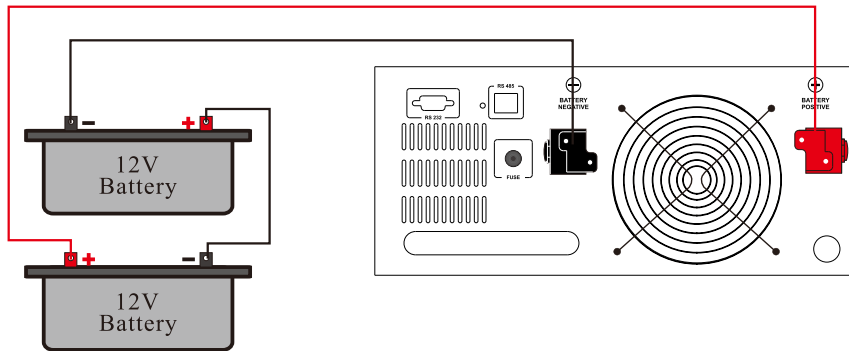

5-3: 48V series battery wiring diagram

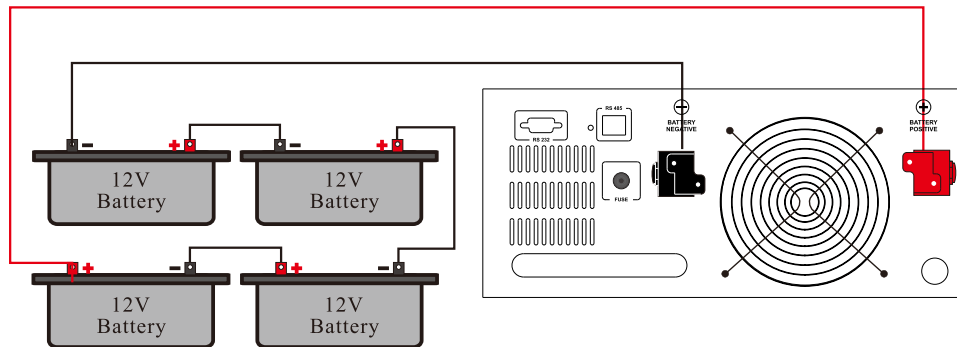

5-4: Input&Output wiring diagram

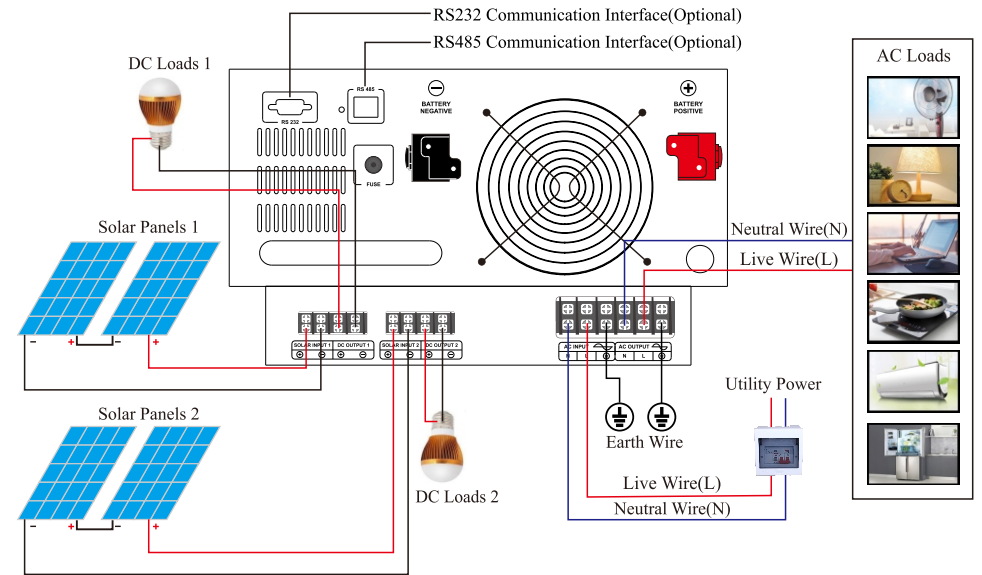

Note:

- Please avoid reverse connection while connecting batteries and PV to the inverter.
- If a generator is used as input power, the operation is as follow: start up the generator, after it runs steadily, connect and turn on inverter. When the inverter starts to work, connect user's equipment to the AC output.
- Capacity of generator ≥ 3 times of the rated capacity of inverter.

6. Maintenance

- 1) The inverter just needs the minimum maintenance. And life of Pb(battery) can be preserved by frequent charge.
- 2) Batteries should be charged for every three months if the inverter is long-term unused.
- 3) Lifespan of battery normally lasts for three to five years. It should be replaced in advance if any battery is found in poor state. And the replacement shall be operated by the professional.
- 4) Batteries should be wholly replaced by the instruction of the supplier.
- 5) For every three months, batteries should be discharged (until the inverter shuts down) and recharged. Every charge (by standard inverter) should last at least for 12 hours.
- 6) Among high temperature area, batteries should be discharged and recharged forevery two months. Every charge (by standard inverter) should last at least for 12 hours.

Note:

- Please shut down the inverter and disconnect AC input before replacing batteries.
- Please do not wear metal jewelry such as ring or watch.
- Please use screwdriver with insulated handle and avoid to place tools or metal objects on batteries.
- Please avoid short circuit or reverse connection.

Warning:

- 1) Battery must not be put in the fire, which may cause explosion.
- 2) Shall not open or damage the battery. Electrolyte released will cause harm to eyes and skin and even intoxication.

7. Error and Solution

7-1: Regular error

Error	Reason	Solution
Unable to boot	Low voltage in battery or overload	Charging the battery or reduce the loads
Shut down with load	Low voltage in battery or overload	Charging the battery or reduce the loads
Alarm for boot	Low voltage in battery or overload	Charging the battery or reduce the loads
Heat of connector	Poor contact	Check and fasten the screws

7-2: Code for alarm

Code for alarm	Reason	Solution
01	Over temperature protection	Check and reduce some loads
02	Reversion of transformer	Please contact the supplier
03	Data-saving error	Please contact the supplier
04	Internal reference voltage error	Please contact the supplier
05	Output short circuit protection	Please check if user's equipment is short circuit.
06	Battery over voltage protection	Please contact the supplier
07	NTC error	Please contact the supplier
08	Communication failure of controller	Please contact the supplier
11	Overload alarm/protection	Please reduce the loads
12	Contra variant error	Please contact the supplier
13	Battery low voltage alarm	AC output is going to stop, please set as AC first with charging mode, and restart the inverter
14	Battery low voltage protection	Please turn into AC first with charging mode, and restart the inverte
15	AC over voltage alarm	Please check the AC input voltage
16	Battery over voltage protection	Please contact the supplier
19	Voltage setting parameters are abnormal	Please check whether the setting parameters meet the setting requirements or not/Rebooting the machine can restore the last saved parameters

8. Technical specification

Model: LSTG		10212/24/48	15212/24/48	20212/24/48	30224/48	40224/48	50248	60248
Rated Power		1000W	1500W	2000W	3000W	4000W	5000W	6000W
Battery Voltage		12/24/48VDC			24/48VDC		48VDC	
Size(L*W*Hmm)		500*300*140				530*335*150		
Package Size(L*W*Hmm)		565*395*225				605*430*235		
N.W.(kg)		12	14	18	20	22	24	26
G.W.(kg)		13.5	15.5	19.5	21.5	23.5	25.5	27.5
Installation Method		Wall-Mounted						
Input	DC Input Voltage Range	10.5-15VDC(Single battery voltage)						
	AC Input Voltage Range	170VAC~275VAC(220VAC)/180VAC~285VAC(230VAC)/190VAC~295VAC(240VAC)						
	AC Input Frequency Range	45Hz~55Hz(50Hz) / 55Hz~65Hz(60Hz)						
	Max AC charging current	0~30A(Depending on the model)						
	AC charging method	Three-stage (constant current, constant voltage, floating charge)						
Output	Efficiency(Battery Mode)	≥85%						
	Output Voltage(Battery Mode)	220VAC±2%/230VAC±2%/240VAC±2%(can be set)						
	Output Frequency(Battery Mode)	50/60Hz±1%(can be set)						
	Output Wave(Battery Mode)	Pure Sine Wave						
	Efficiency(AC Mode)	>99%						
	Output Voltage(AC Mode)	220VAC±10%/230VAC±10%/240VAC±10%(can be set)						
	Output Frequency(AC Mode)	Follow input						
	Output waveform distortion Battery Mode)	≤3%(Linear load)						
	No load loss(Battery Mode)	≤0.8% rated power						
	No load loss(AC Mode)	≤2% rated power(charger does not work in AC mode)						
No load loss(Energy saving Mode)	≤10W							
Battery Type	Custom battery	Charging and discharging parameters of different types of batteries can be set through the operation panel by oneself						
Protection	Battery lowvoltage alarm	Factory default: 11V(Single battery voltage)						
	Battery lowvoltage protection	Factory default: 10.5V(Single battery voltage)						
	Battery overvoltage alarm	Factory default: 15V(Single battery voltage)						
	Battery overvoltage protection	Factory default: 17V(Single battery voltage)						
	Battery overvoltage recovery voltage	Factory default: 14.5V(Single battery voltage)						
	Overload power protection	Automatic protection (battery mode), circuit breaker or insurance (AC mode)						
	Inverter output short circuit protection	Automatic protection (battery mode), circuit breaker or insurance (AC mode)						
	Temperature protection	>90°C(Shut down output)						

Alarm	A	Normal working condition, buzzer has no alarm sound	
	B	Buzzer sounds 4 times per second when battery failure, voltage abnormality, overload protection	
	C	When the machine is turned on for the first time, the buzzer will prompt 5 when the machine is normal	
Inside Solar controller (Optional)	Charging Mode	MPPT or PWM	
	Charging current	10A~60A(PWM或MPPT)	10A~60A(PWM)/10A~100A(MPPT)
	PV Input Voltage Range	PWM: 15V-44V(12V system); 30V-44V(24V system); 60V-88V(48V system) MPPT: 15V-120V(12V system); 30V-120V(24V system); 60V-120V(48V system)	
	Max PV Input Voltage(Voc) (At the lowest temperature)	PWM: 50V(12V/24 system), 100V(48V system); MPPT: 150V	
	PV Array Maximum Power	12V system: 140W(10A)/280W(20A)/420W(30A)/560W(40A)/700W(50A)/840W(60A)/1120W(80A)/1400W(100A); 24V system: 280W(10A)/560W(20A)/840W(30A)/1120W(40A)/1400W(50A)/1680W(60A)/2240W(80A)/2800W(100A); 48V system: 560W(10A)/1120W(20A)/1680W(30A)/2240W(40A)/2800W(50A)/3360W(60A)/4480W(80A)/5600W(100A)	
	Standby loss	≤3W	
	Maximum conversion efficiency	>95%	
Working Mode	Battery First/AC First/Saving Energy Mode		
Transfer Time	≤4ms		
Display	LCD		
Thermal method	Cooling fan in intelligent control		
Communication(Optional)	RS485/APP(WIFI monitoring or GPRS monitoring)		
Environment	Operating temperature	-10°C~40°C	
	Storage temperature	-15°C~60°C	
	Noise	≤55dB	
	Elevation	2000m(More than derating)	
	Humidity	0%~95% (No condensation)	

Above parameter revision change without notification.

9. Appendix--485 Communication Port

Definition of pin:

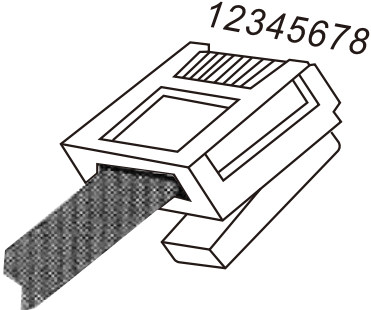
PIN1-----RS485-A	
PIN2-----RS485-B	
PIN3-----NC	
PIN4-----GND	
PIN5-----NC	
PIN6-----NC	
PIN7-----NC	
PIN8-----NC	

NC: refer to as not connect.

Warranty Card

Customer Name: _____ Tel.: _____

Address: _____

Brand: _____ Model: _____

Serial No.: _____ Date of Purchase: _____

Bought From: _____

Invoice Number: _____ Invoice Price: _____

Warranty Instruction

- Please keep this warranty card as proof of maintenance.
- The warranty period is 1 year from the date of purchase.
- During the warranty period, under the condition of normal use and maintenance, if damage caused by the product's own quality, the company will provide free repair and replacement parts after verification.
- The company reserves the right to maintain and interpret all contents.

Free maintain won't be given under the following circumstance:

- The damage caused by the manipulation that hasn't follow the requests of the manual.
- The product has been repaired, modified by technicians other than our company's, and any internal parts of the product have been replaced by users.
- The product number has been altered or product is inconsistent with the warranty card.
- Damage caused by careless use, penetration of water or other substances into the product.
- Damage caused by accident or natural disaster.

Certificate

Name: _____

Model: _____

Inspectors: _____

Date: _____

Products have been tested qualified by standard and permitted to deliver.